

Complete Shower Room Installation & Operation Manual

9039

SIZE: 90X90X215cm



Cautions in Installation and Using

Thanks for selecting our shower room series. To guarantee safe and normal operation as well as prolong service lifetime. Pls read Instruction carefully before installation.





Note: We are dedicated to improving products quality, find something new in what is old, we would if there is difference in the Instruction until further notice. Any discomfort, we ask your pardon.

Directory

1.Tool contents	-----	3
2.Accessory list	-----	4-6
3.Pipe and drain installation drawing	-----	7
4.Installation Procedure	-----	8-24
5.Electric appliance instruction	-----	25
6.Notes	-----	26
7.Delivery and storage notice	-----	26
8.Trouble shootings	-----	27

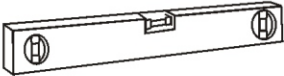

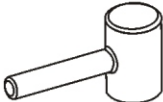
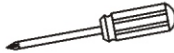

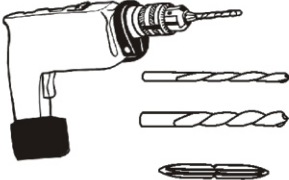



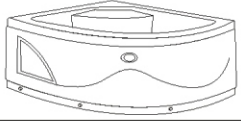

(1)

1.self-provide tool

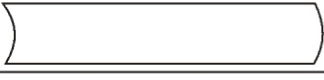
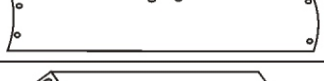
Name	Tool
Track level bar	
Tape measure	
Ajustable spanner	
Rubber hammer	
Phillips screwdriver	
Scissors	
Glass cement	
electric drill	
3mm aiguille	
6mm aiguille	
tap drill	

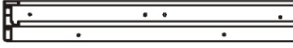
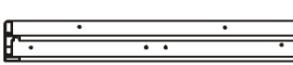





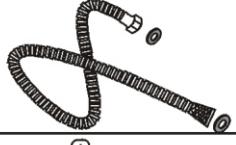

(2)

2.Partial accessory list

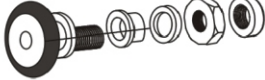
Item	Name	Accessory	Quantity
1	(1.1)Tub		1
	(1.2)Middle Backboard		1
	(1.3)Roof		1
2	(2.1)Backboard glass		1
	(2.2)Backboard glass		1
	(2.3)Arch fixed door glass		2
	(2.4)Arch flexible door glass		2
3	(3.1)Side upright column		2
	(3.2)Upper rail		2
	(3.3)Bottom rail		2
4	(4)Knob		2
5	(5)Hand shower		1
6	(6)Top shower		1

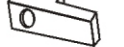
(3)

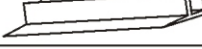
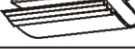
2.Partial accessory list

Item	Name	Accessory	Quantity
7	(7.1)hand shower		1
	(7.2)hand shower tube		1
8	(8)Lifting rod		1
9	(9)Soap container		1
10	(10)eccentric wheel		8
11	(11)Cold and hot water hose		2
12	(12.1)Glass positioning fixture		8
	(12.2)Glass fixture		4
13	(13.1)Magnetic strip		2
	(13.2)Waterproof belt		2
	(13.3)U style thong		2
14	(14.1)St 4*16mm self tapping srew		32
	(14.2)St 4*10mm self tapping srew		12

(4)

3. Pipe and drain installation drawing

C=Cold water inlet
H=Hot water inlet
D=Drain



(5)

4, Installation Procedure

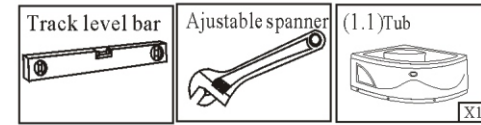

1.) Put track level bar on the tub, and adjust foot's screw by adjustable spanner, and keep it to the leveling

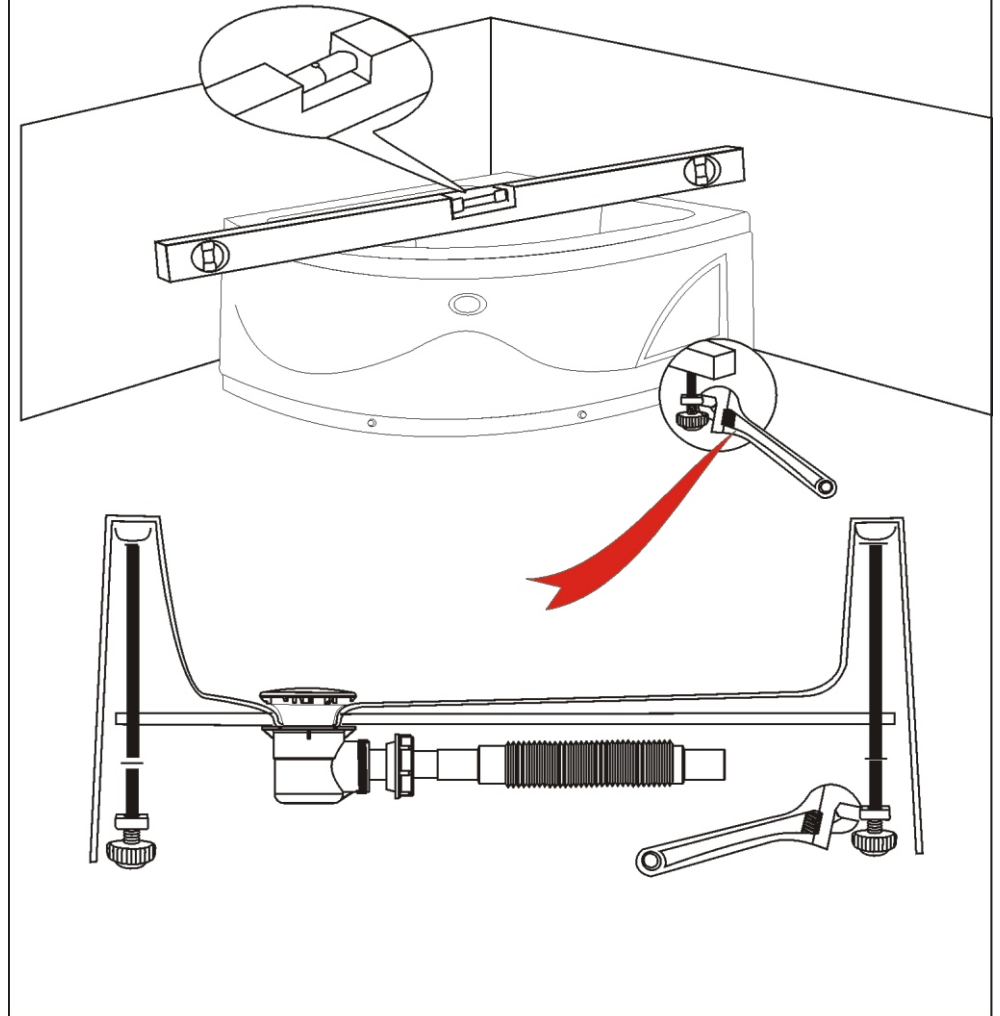

(6)

4,Installation Procedure

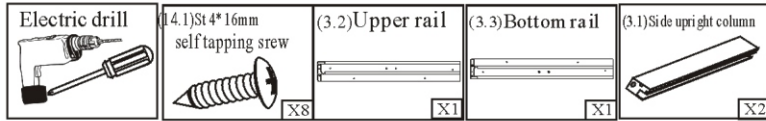

2:) Build up the frame. Make sure the rails and upright aluminums are suitable. And find the difference between up rail and down rail.

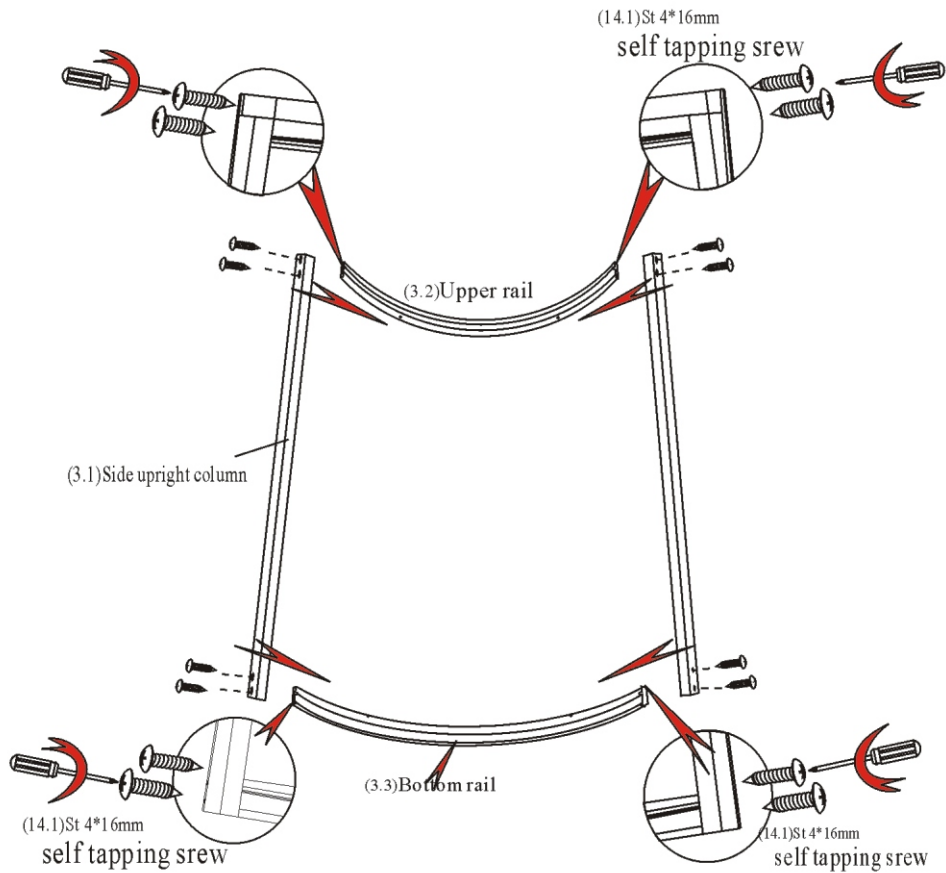

(7)

4,Installation Procedure

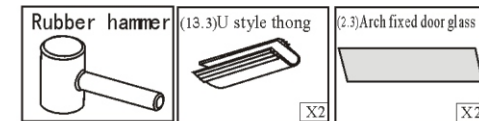

3:) Fit the fixed glass into the frame, after fitting the rubber seal into glass one side, and then knock the glass carefully by hammer.

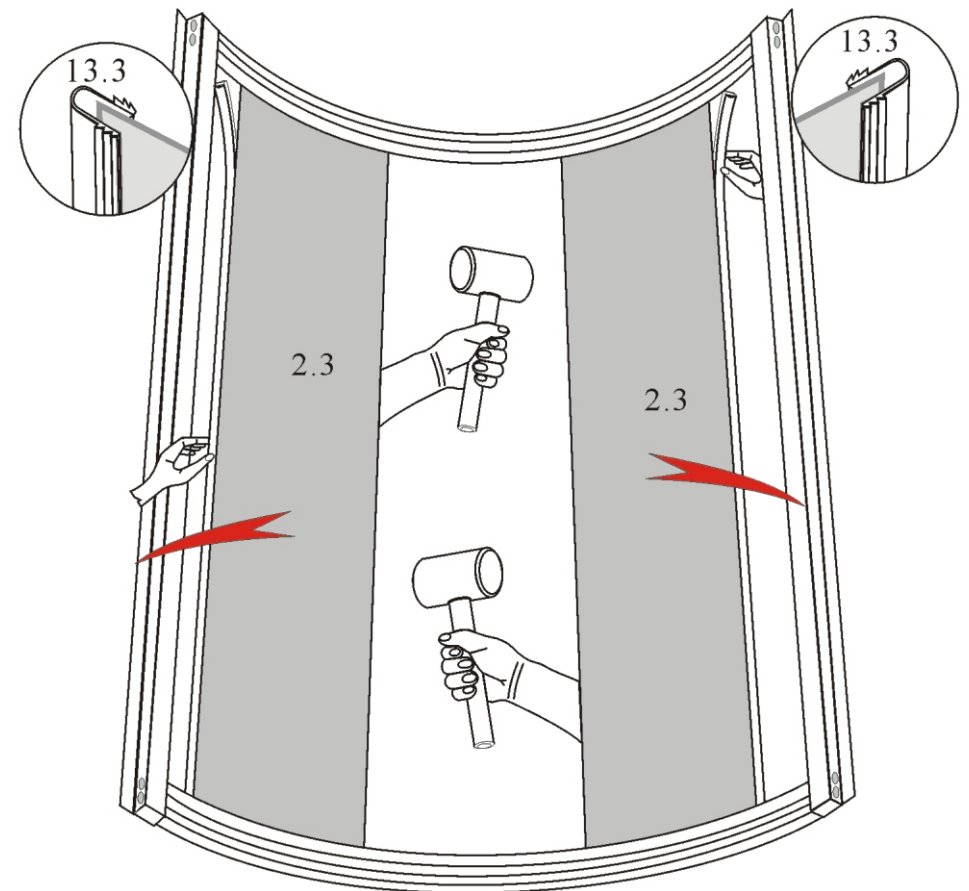

(8)

4,Installation Procedure



4 :) Fit the rubber seal to glass, and use hammer to knock the aluminum panel, to make it fit with glass. Then, fix the aluminum panel by screws.

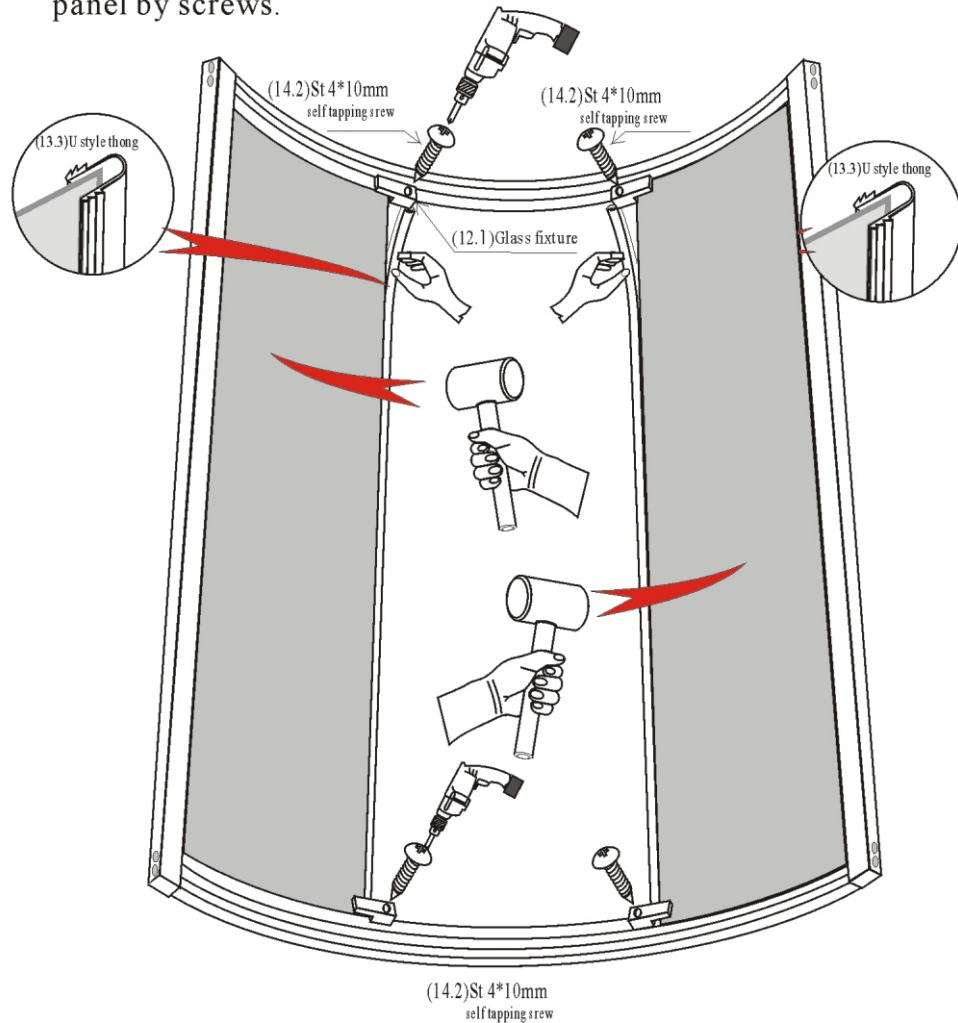

(9)

4,Installation Procedure

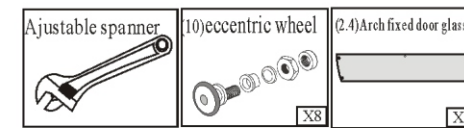

5 :) Put the roller into glass door holes, and adjust the roller screw, then hang the door into up rails. Then fix all of roller, to make sure the door move smoothly.

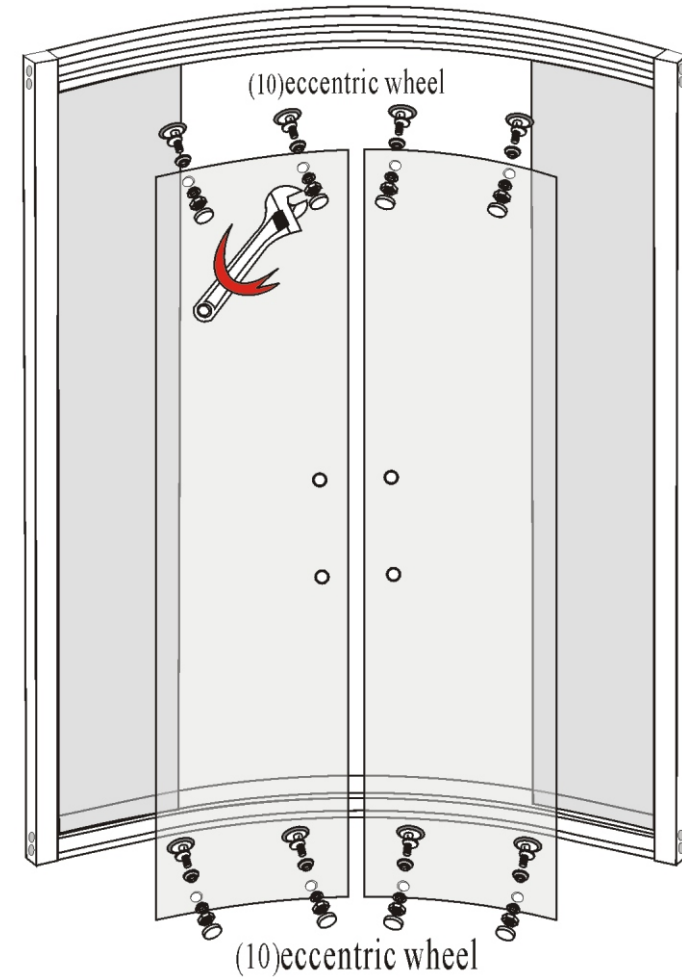

(10)

4, Installation Procedure

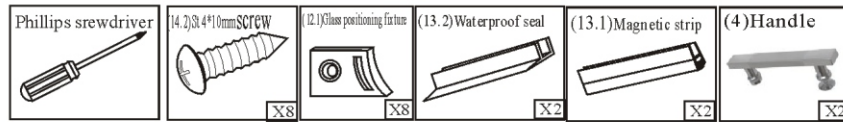

6:) Fit the handle into flexible door, fix rubber position (12) by screws (14.2). Fit the magnetic seal and waterproof belt.

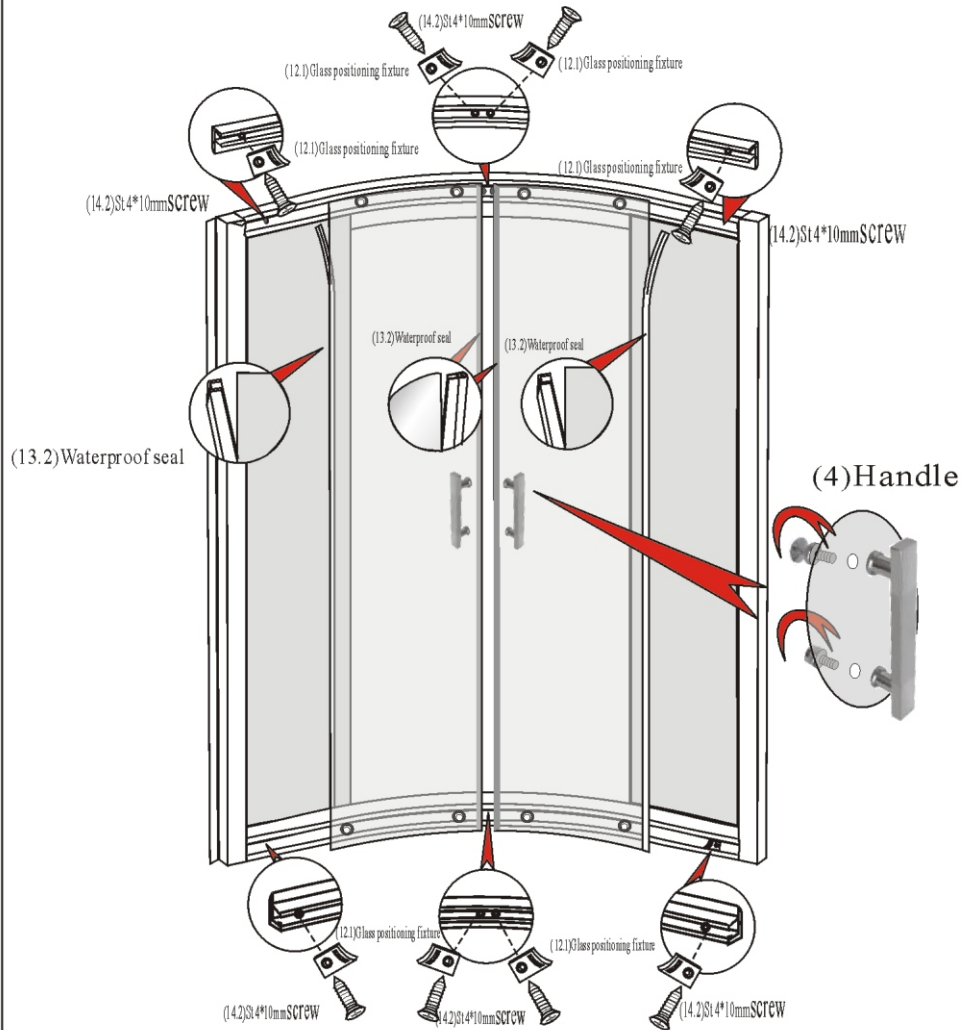

(11)

4, Installation Procedure

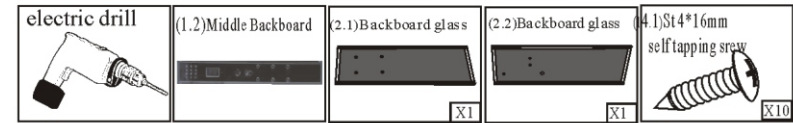

7:) Connect back board and glass room by screw (14.1), fit the pipes.



(12)

4,Installation Procedure

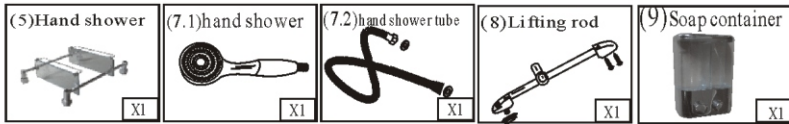

8:) Fit the soap container, handle shower, and glass holder.
(8) Lifting rod

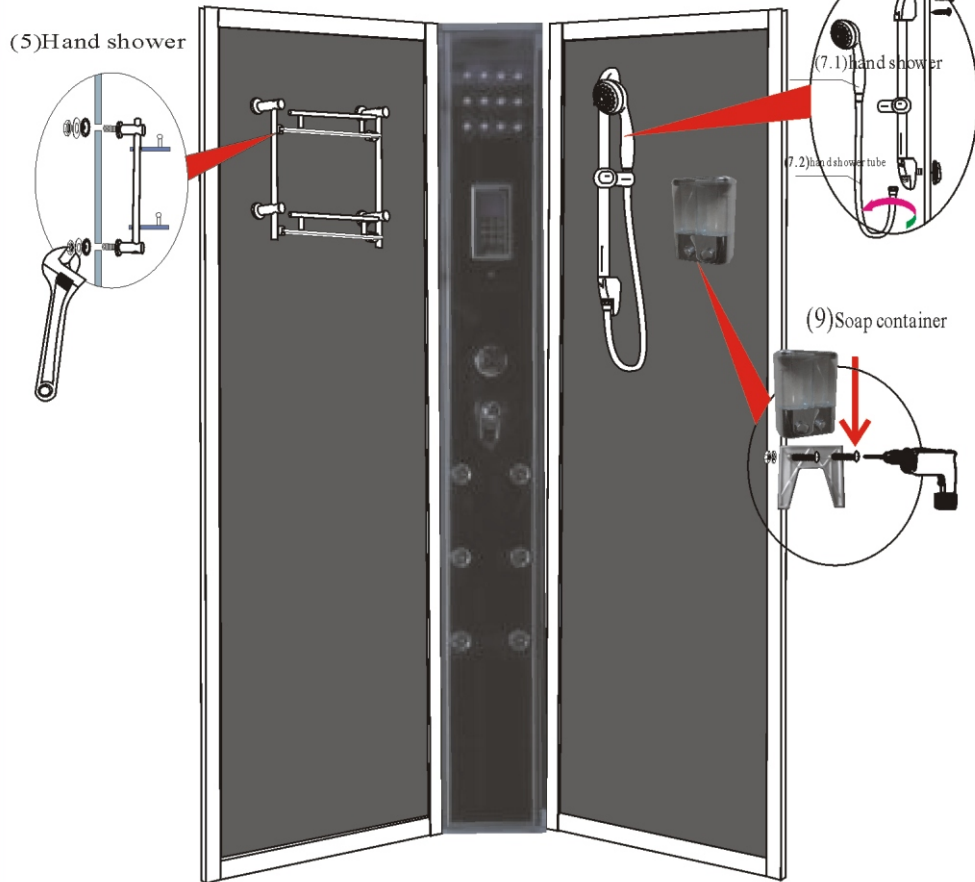

(13)

4,Installation Procedure

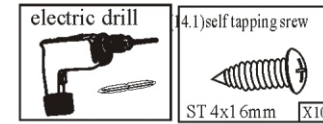

9:) Connect back board and glass room by screw (14.1), fit the pipes.

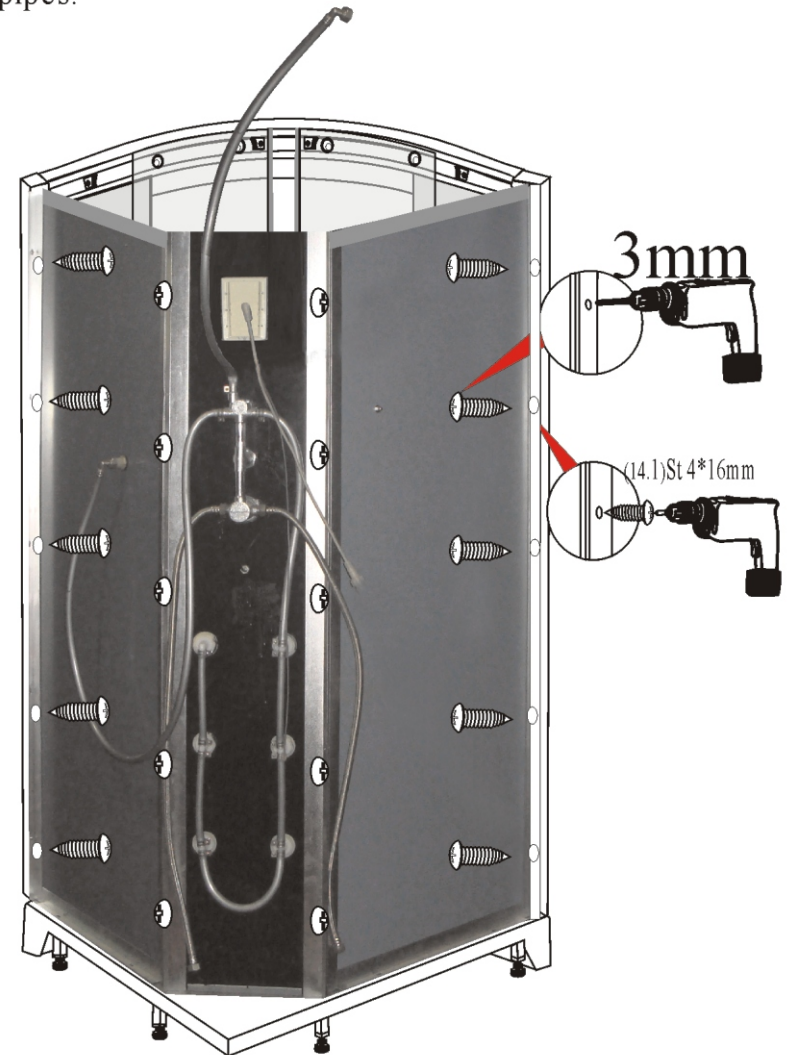

(14)

4,Installation Procedure

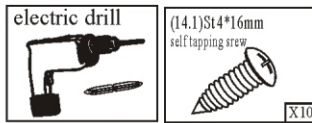

10:) Put the back board and glass room on the tub,connect them and fix them by screw (14.1)

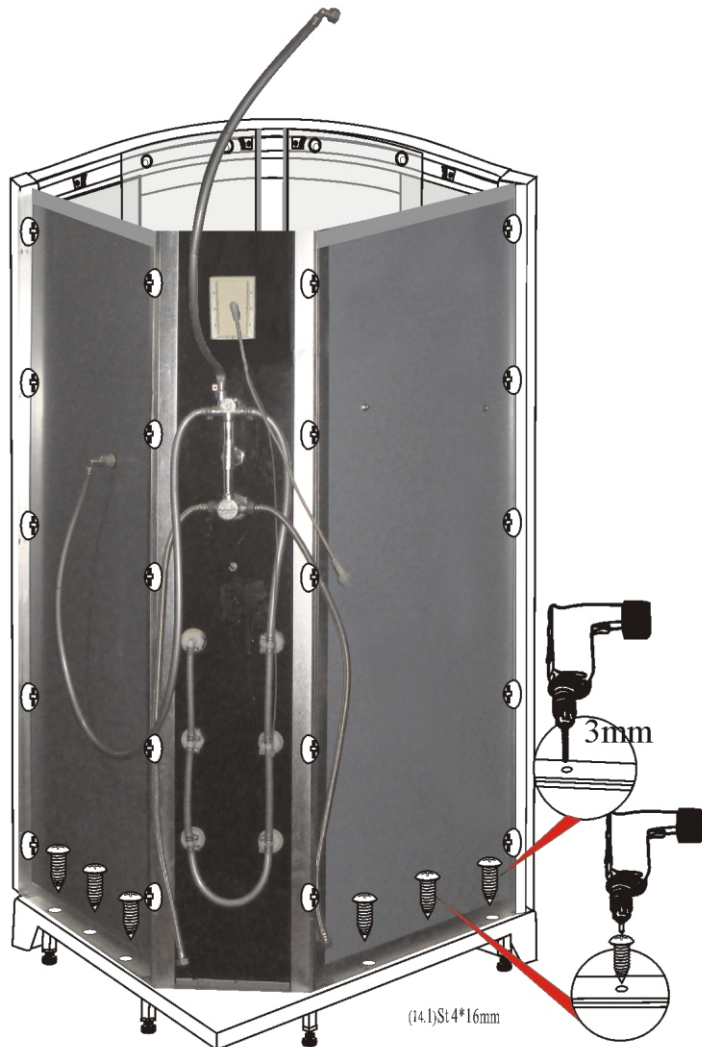

(15)

4,Installation Procedure

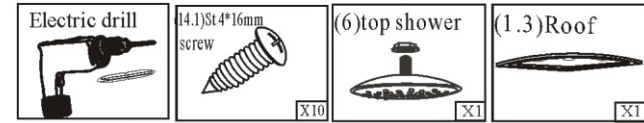

11.) Fix top cover with glass room by (14.1)ST4*16 screws. Connect all of pipes and wires as picture.

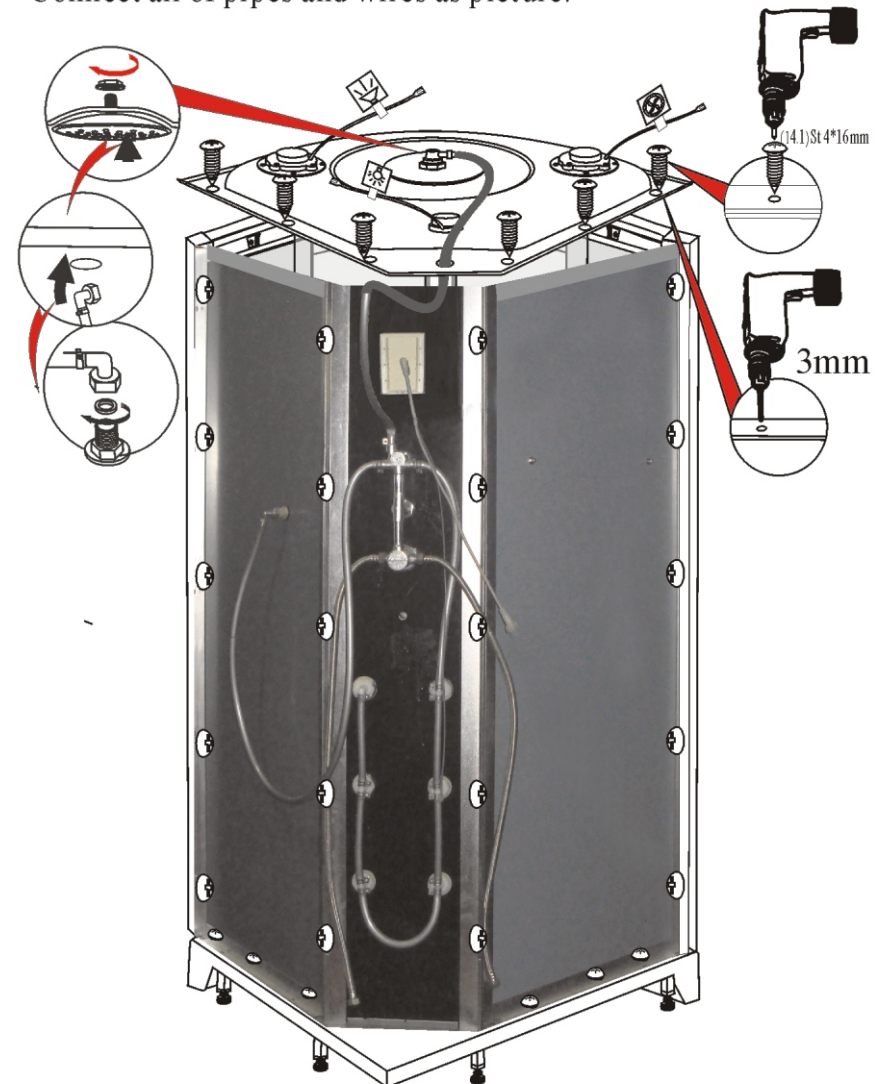

(16)

4, Installation Procedure

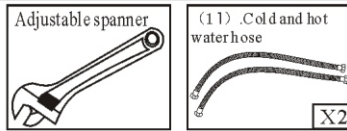

12. Connect cold and hot water with installed shower room by adjustable spanner, then plug in .

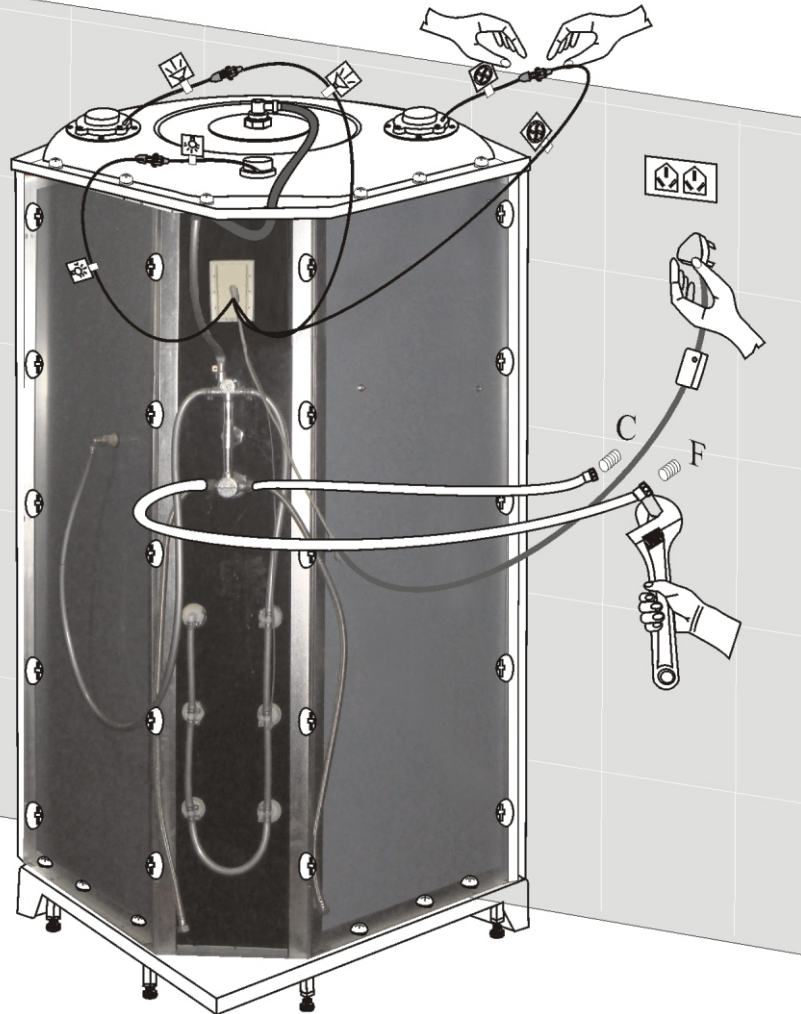

(17)

5, Electric appliance instruction

The electrical things used in the product all have the electrical leakage protection and are connected to the ground wire.

During installation professional workers should responsible for it.

Voltage:220V+10%

Water pressure:0.1-0.4Mpa



Power line section must above 2.5mm, it must have dependent power control switch. Power plug's demension is three-core 16A, We would responsible for product quality if you install and operate according to instruction.









(18)





5 Electric appliance instruction

1、 Please power the controller first .After you push any position of the touch screen, the LCD screen will be light, and the controller is ready for working .



2、 Push  'FAN' key, fan icon flash, the fan working, you can push  'FAN' key again to stop fan working .



3、 Push  'Top Light' key, the top lamp light,you can push  'Top Light' key again to stop top lamp working. Push  'Back Light' key, the back lamp light, you can push  'Back Light' key again to stop back lamp working.



4、 Push  'FM' key on the panel once, the radio working, the number window show the current radio frequency. Push  'FM' key again, radio turn off .

On radio: (Frequency range : FM87.5 ~ 108 MHz). the number window show the current frequency, push  'UP' key or  'DOWN' key on the touch screen to be up or down station searching by single step. Push the key for half second can be automatically station searching. When the station is searched, push the  'MEM' key for 2 seconds, the current station frequency can be stored. Click  'MEM' key can change the channel upward with the frequency scale of 1-10.

5 Electric appliance instruction

5、 Volume setting : when radio is operation ,push  ' Volume up' or  ' Volumedown' key to set up volume, push the key after 3 seconds later, the volume continuously up or down.

6、 When the other functions (except light functions) turn off , push  'O3' key on the touch screen, The O3 icon flash and the Ozonizer working, push  'O3' key again, ozonizer stop working.

7、 Finish washing, push  'POWER' key to turn off the controller. At this time, the LCD screen display count down for 60 second, the controller automatic turn off the Fan, Light, Radio, CD . The controller will standing again after 60 second. You can push  'POWER' key to restart the controller.

Parameter:

Voltage Inlet	AC 210-230V
Frequency	50HZ
Control System Voltage	DC 12V
Lamp Power	AC 12V,10W
Fan Power	DC 12V,2W
Radio Power	5W

6:Notes

1. It is unadvisable to take a shower after drunk.
2. It is unadvisable to have a shower immediately after acute sports.
3. Please avoid bath or shower in morning.
4. Keep the temperature of dressing room near to the bathroom 拵
5. If you feel uncomfortable while having a shower , you should go out of the shower room as soon as possible.
6. The time of shower is advisable to be between 15 minutes and 20 minutes, no longer .
7. Drink water to supplement moisture after shower or bathing.
8. People who suffer from heart disease, high blood pressure, diabetes or who feel unwell or pregnant woman are unadvisable to have bathing ,massage or shower.

7,Delivery and storage notice

- 1,It is prohibited to store organic solvent together, such as formic acid and methanol.
- 2.Handle with care if it need transport.Heavy stress,mechanical impact and sharp pounding is prohibited.
- 3.It should keep it dry and airy and make sure there is no etchant gas.

8,Trouble shootings

Troble	Cause	Remedy
No power	1.Electric power don't connect well,leak swtich is cut off.	Access to power
	2.Fuse wire is broken,switch of control panel is failure.	Maintain or replace
	3.GFCI is out of work	Check GFCI
No head shower	1. water pressure is abnormal	Check water pressure
	2.Cold and hot water switch is closed.	Turn on the cold and hot water switch
	3.chocking nozzle	Clean
Water pipe leakage	1. Seal ring damaged	Replace seal ring
	2.Tie in don抐 connect well	Connect it again
No radio	1.Connecting wire is cut	Make connection
	2.Loudspeaker is broken	Replace a new one
Phone unuable	1.Telephone wire don抐 connect well	To make contact telephone line
	2.Control panel is broken	Maintain or replace
No light	1. Bulb is broken,ballast is broken	Replace
	2.Break of ballast	To make contact
	3.Control panel is broken	Maintain or replace
No exhaust	1.Fan is broken	Replace
	2.Tie-in is not connect well	To make contact
	3.Control panel is broken	Maintain or replace

If complete shower room cant work normally, please check it as compare above then obstacle avoidance.

If customers cant make sure the cause of obstacle or lack of ability mantianance.Please contact distributer.